

FP03-0042-00

1/21

Fig.1

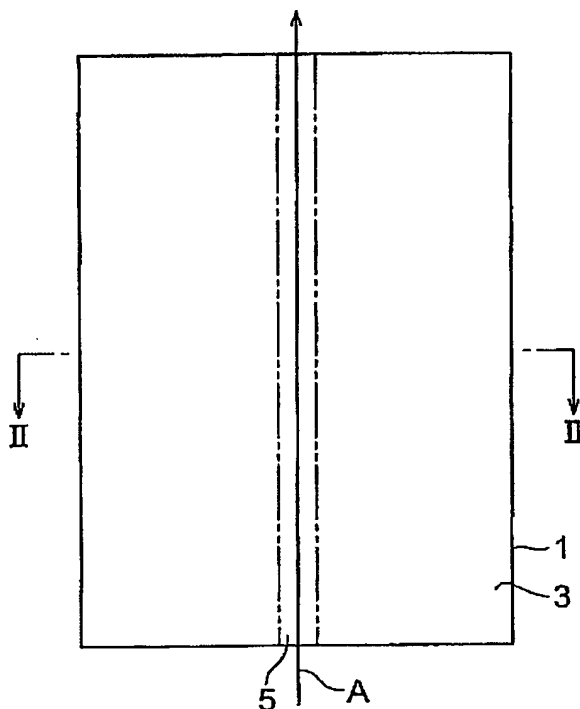
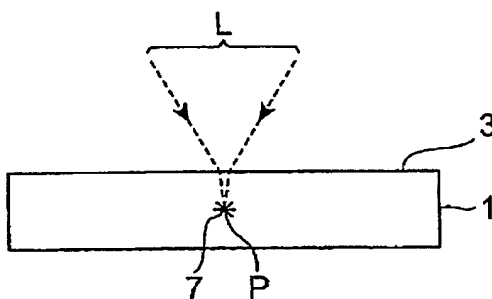

Fig.2



FP03-0042-00

2/21

Fig.3

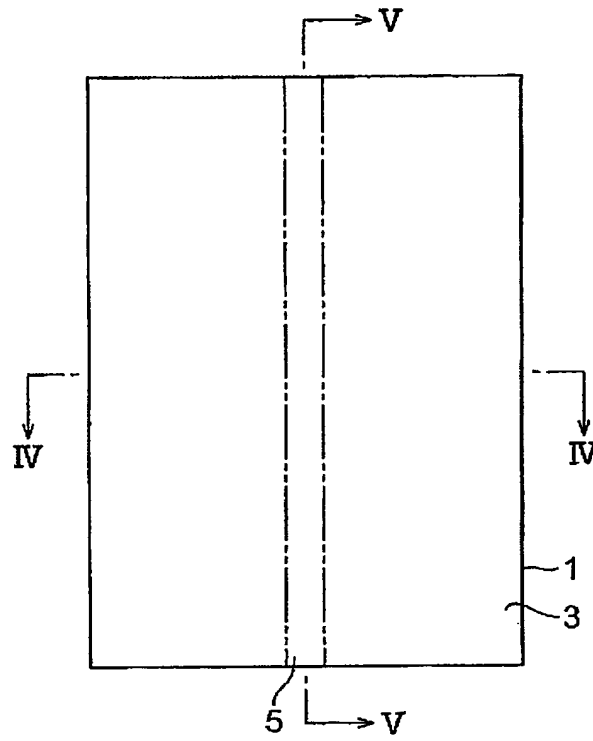
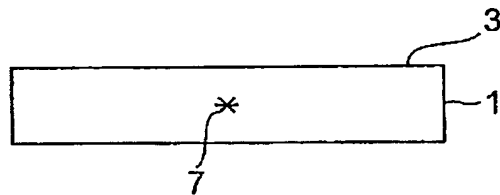

Fig.4



FP03-0042-00

3/21

Fig.5

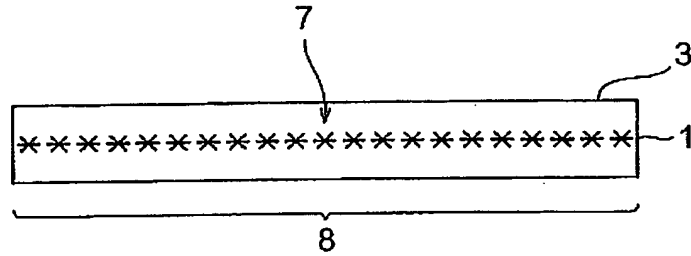
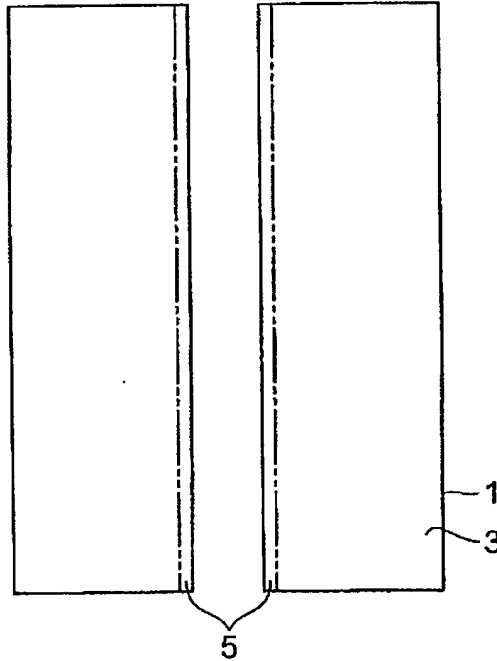
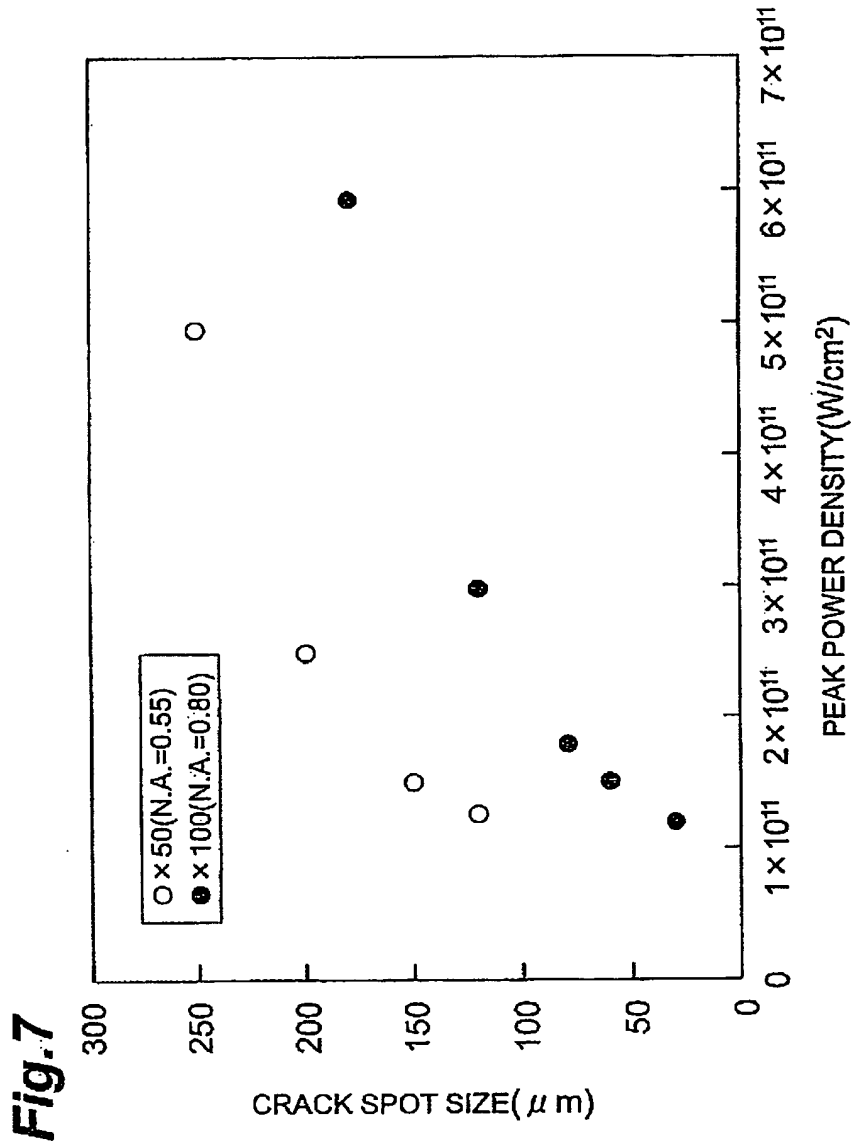

Fig.6



FP03-0042-00

4/21



FP03-0042-00

5/21

Fig.8

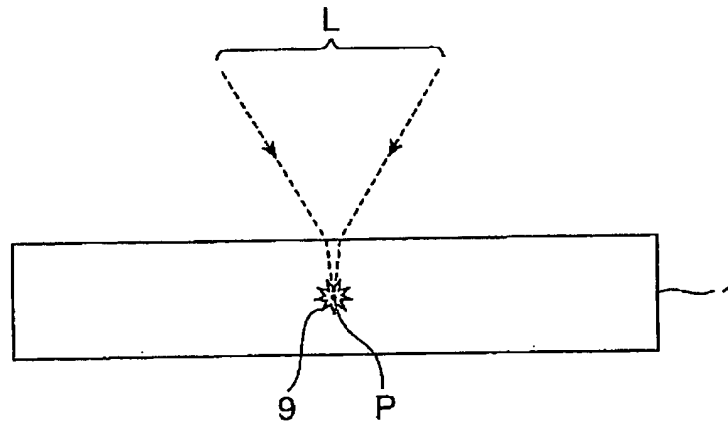
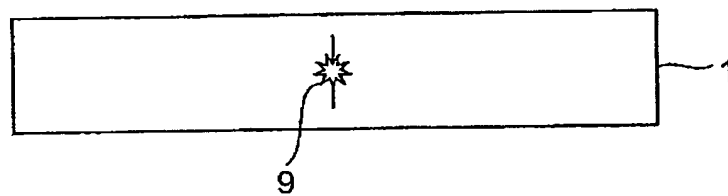

Fig.9



FP03-0042-00

6/21

Fig.10

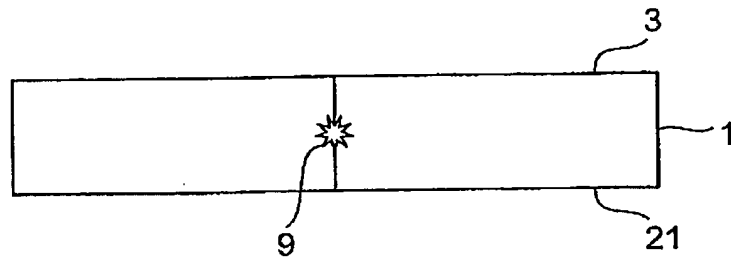
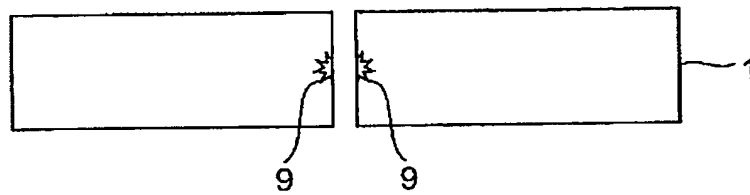

Fig.11



FP03-0042-00

7/21



Fig.12

FP03-0042-00

8/21

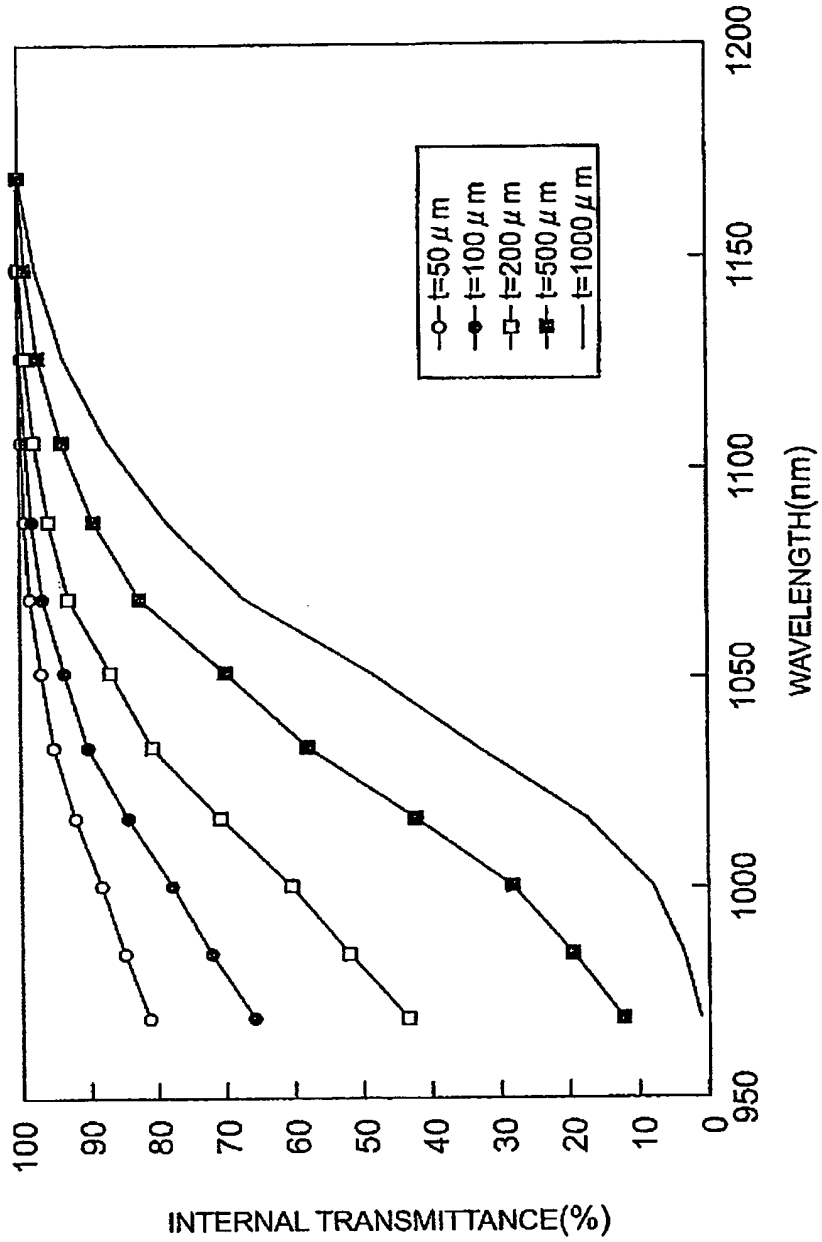

Fig.13

FP03-0042-00

9/21

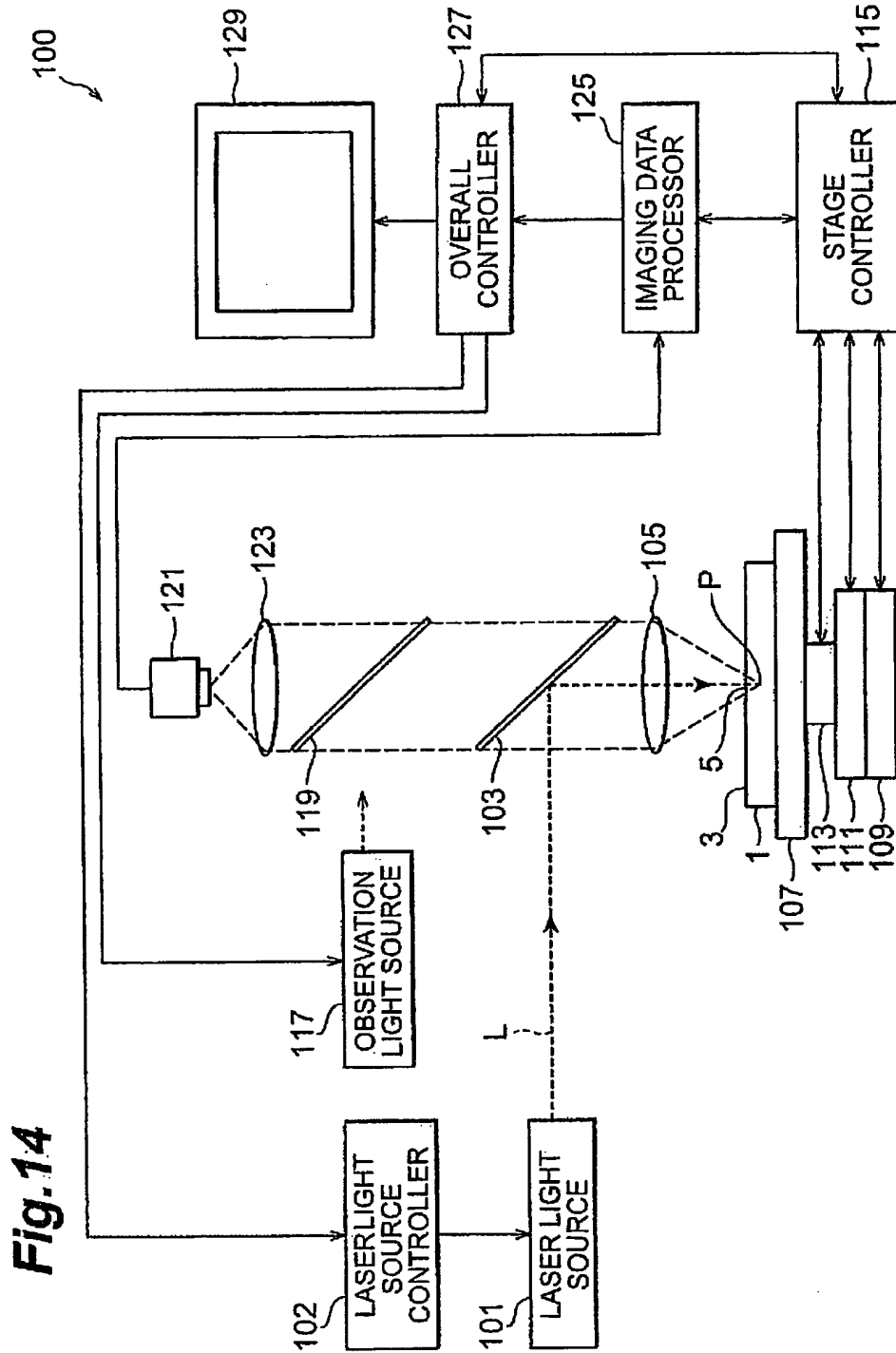
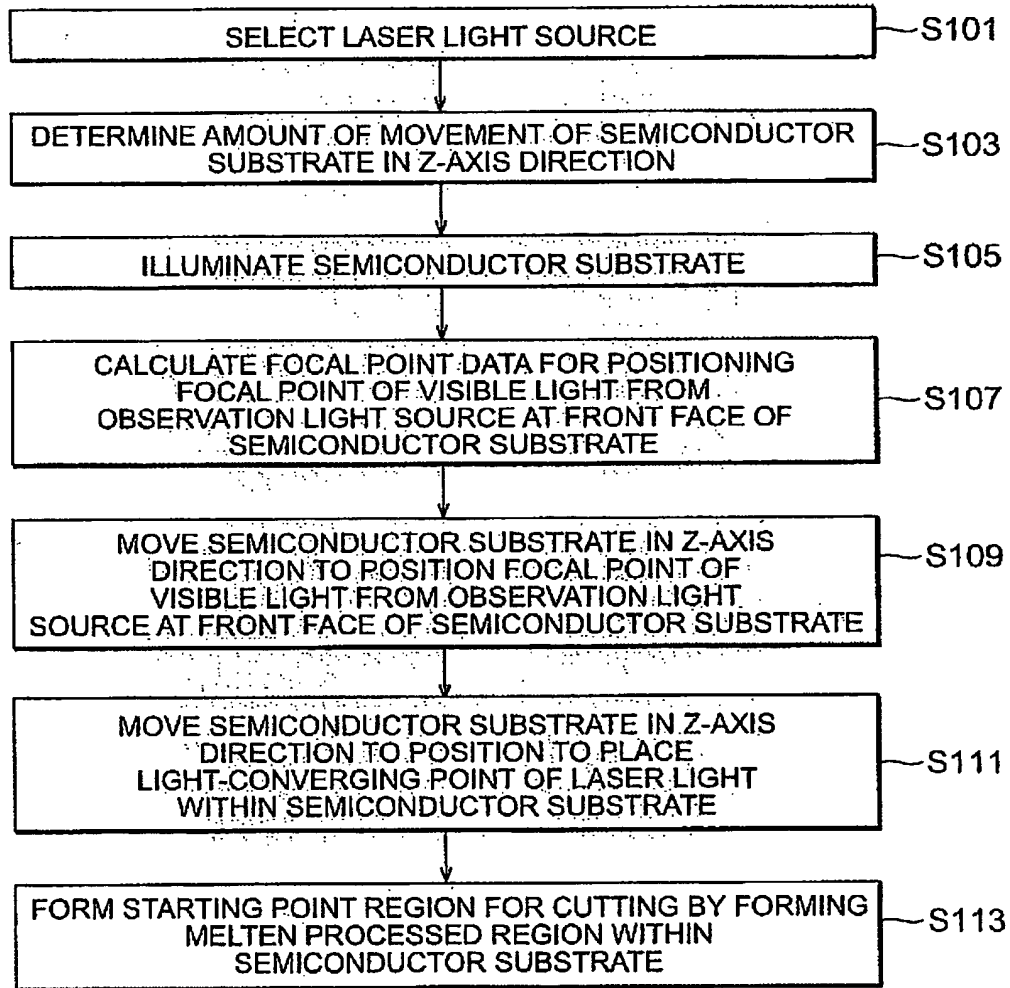

Fig. 14

FP03-0042-00

10/21

Fig.15



FP03-0042-00

11/21

Fig.16

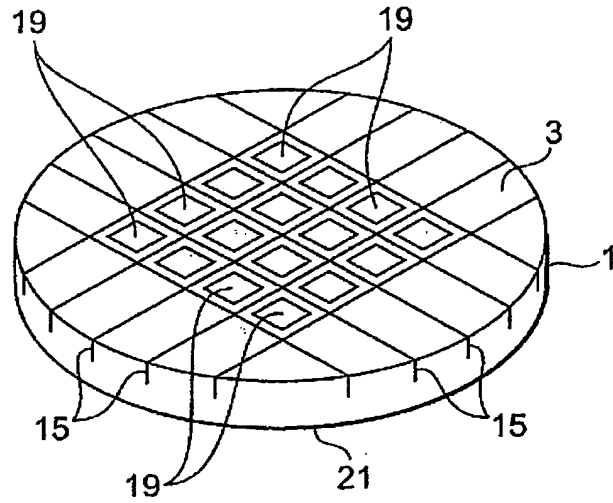

FP03-0042-00

12/21

Fig.17

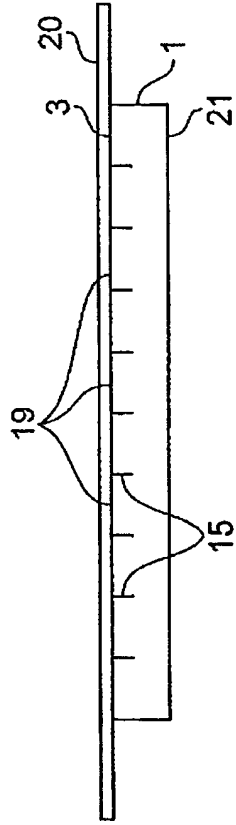

Fig.18

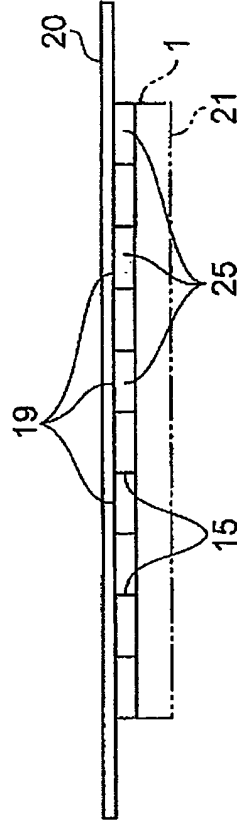
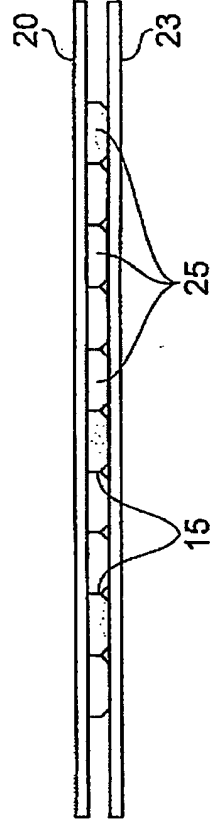

Fig.19



FP03-0042-00

13/21

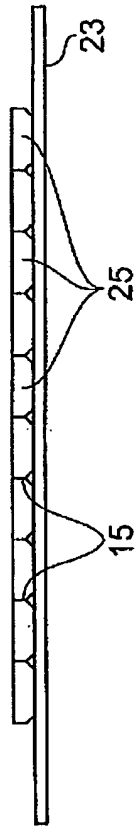

Fig. 20

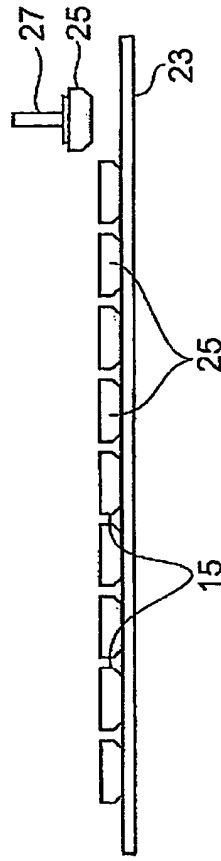
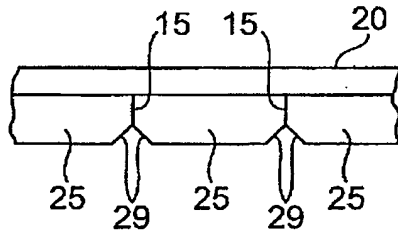

Fig. 21

FP03-0042-00

14/21

Fig.22



FP03-0042-00

15/21

Fig.23A

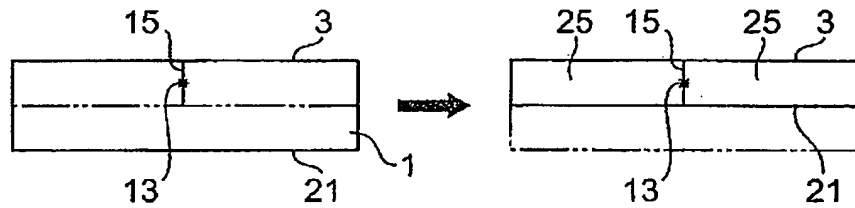

Fig.23B

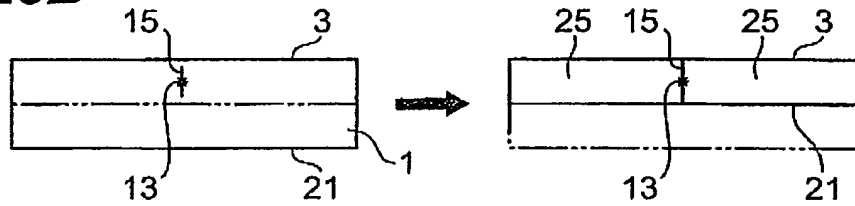

Fig.24A

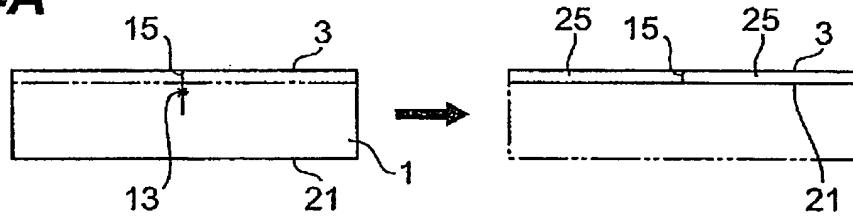
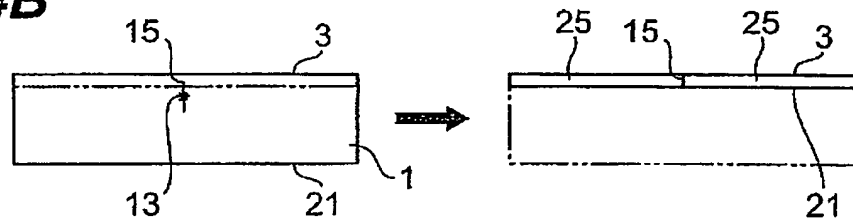

Fig.24B



FP03-0042-00

16/21

Fig.25A

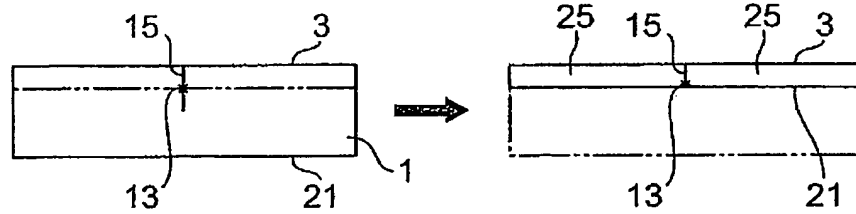

Fig.25B

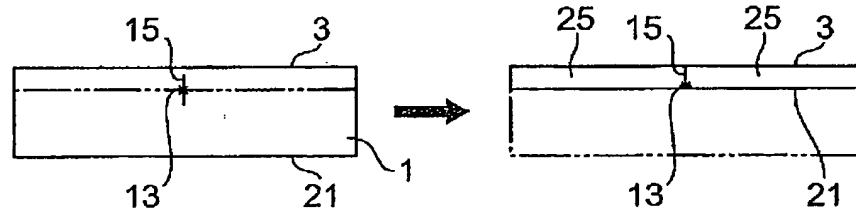

Fig.26A

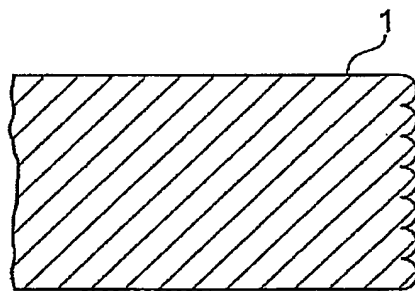
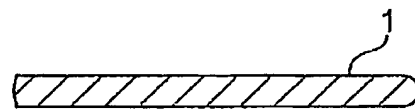

Fig.26B



FP03-0042-00

17/21

Fig.27

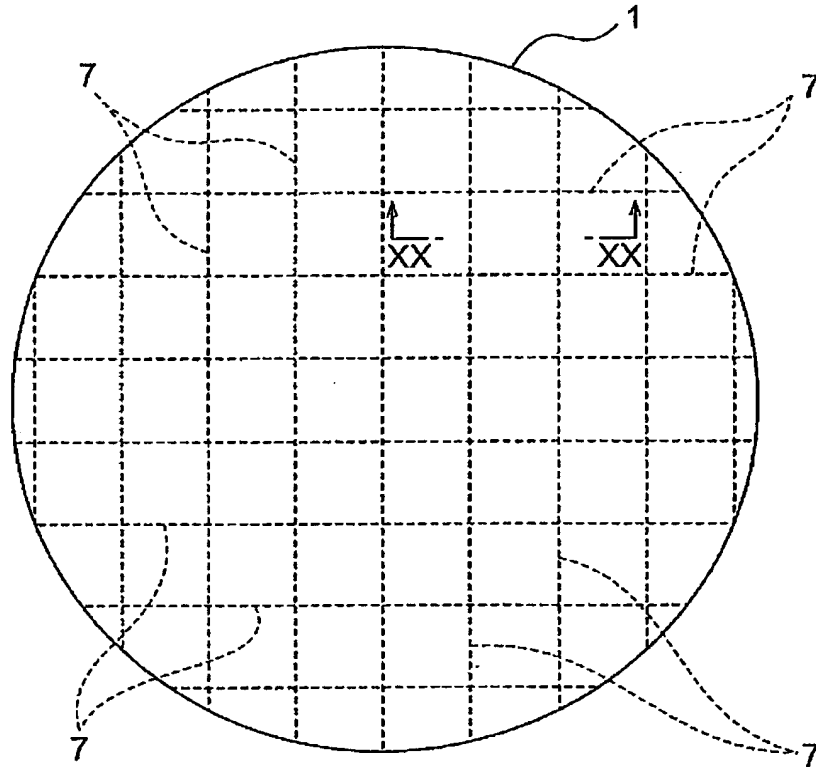

FP03-0042-00

18/21

Fig.28

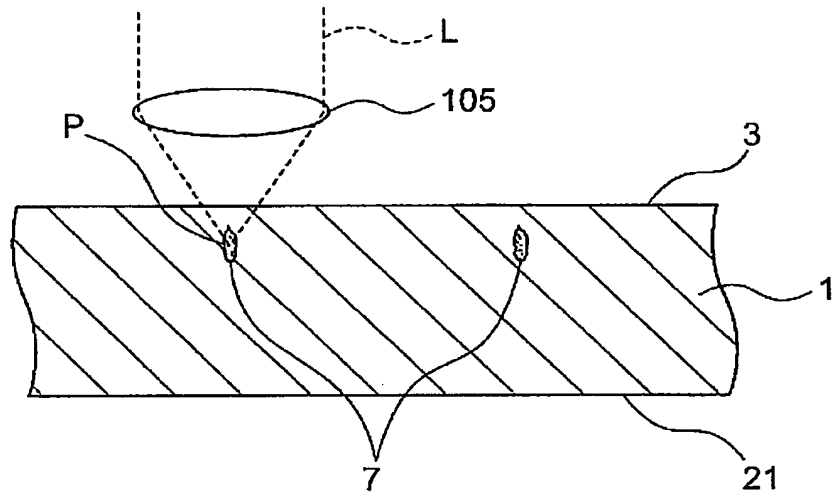
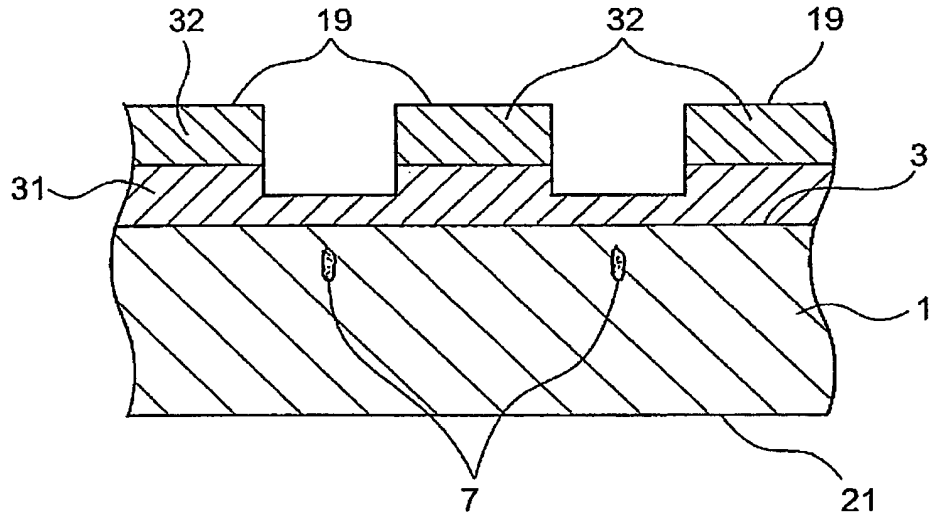

Fig.29



FP03-0042-00

19/21

Fig.30

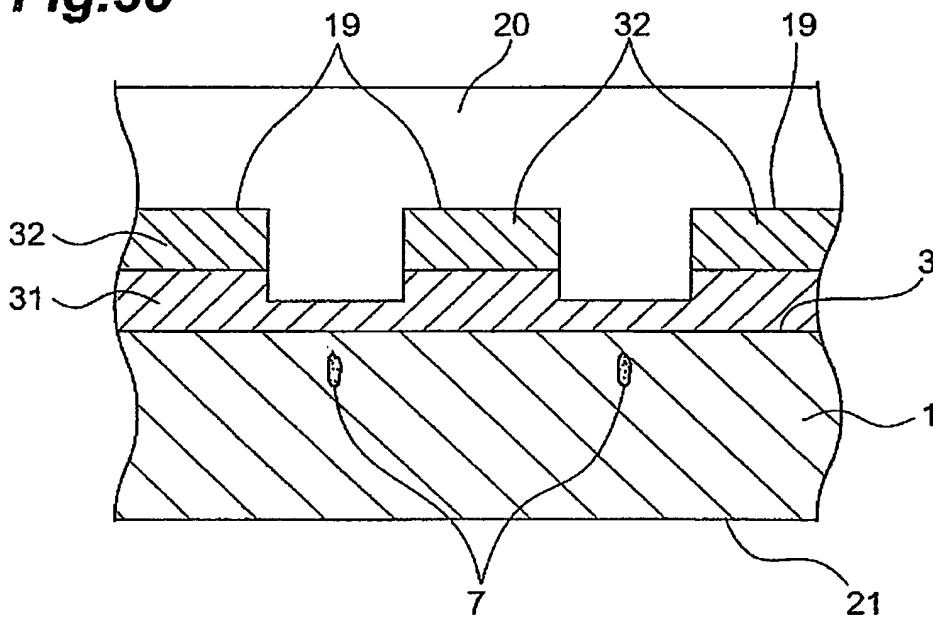
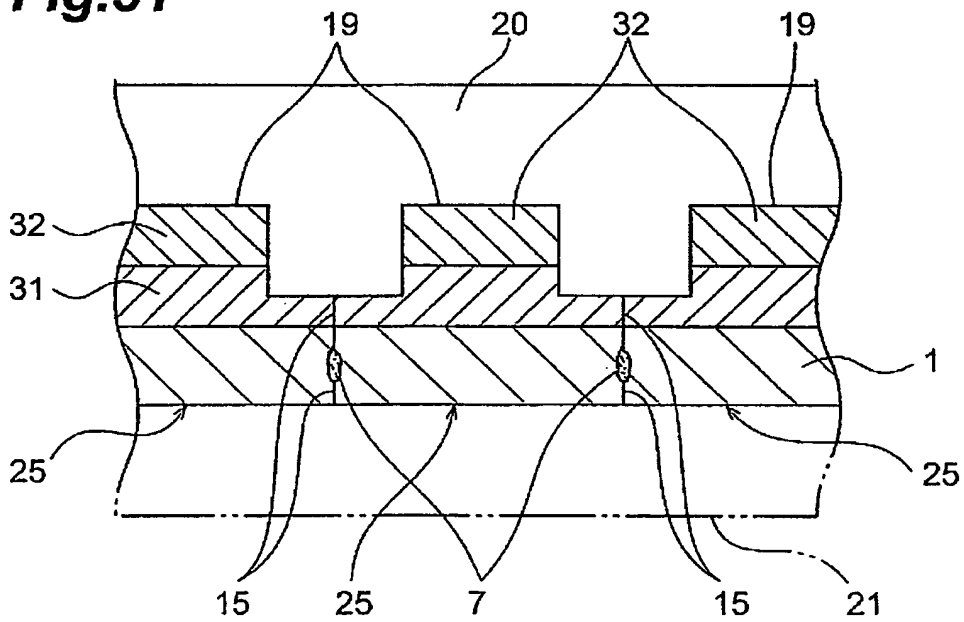

Fig.31



FP03-0042-00

20/21

Fig.32

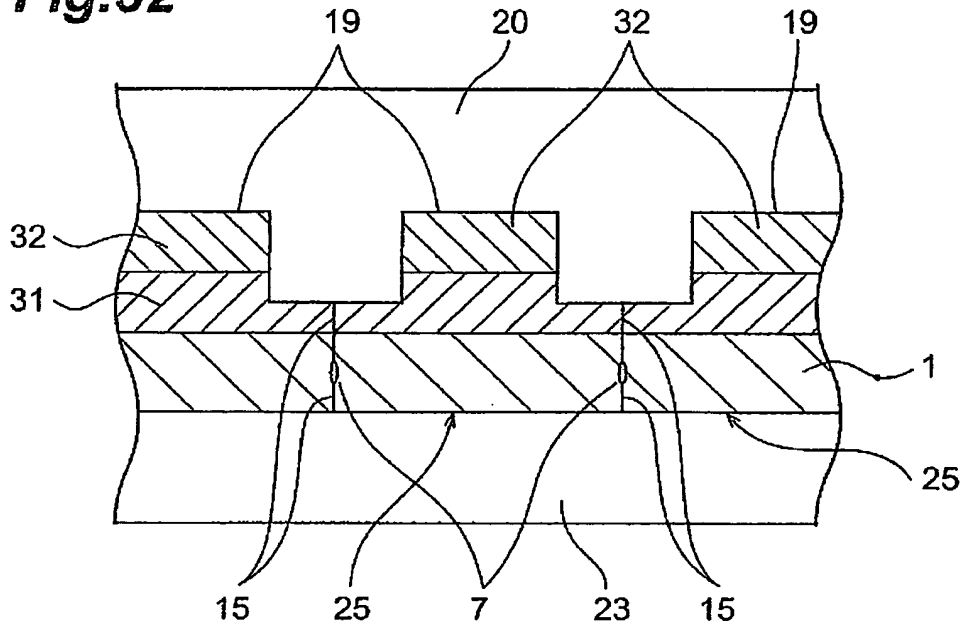
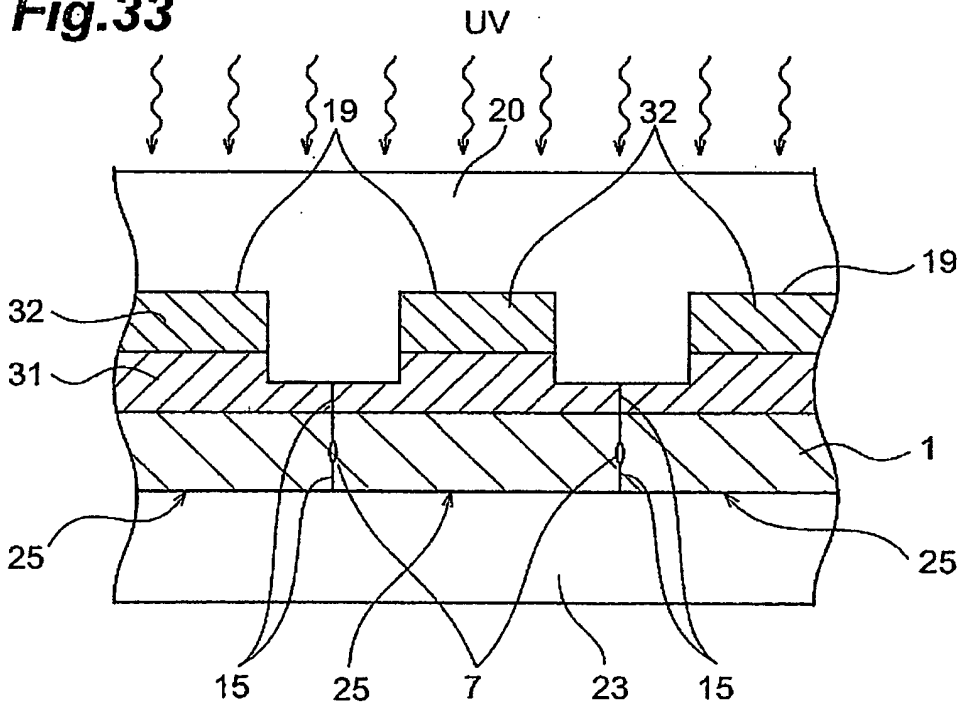

Fig.33



FP03-0042-00

21/21

Fig.34

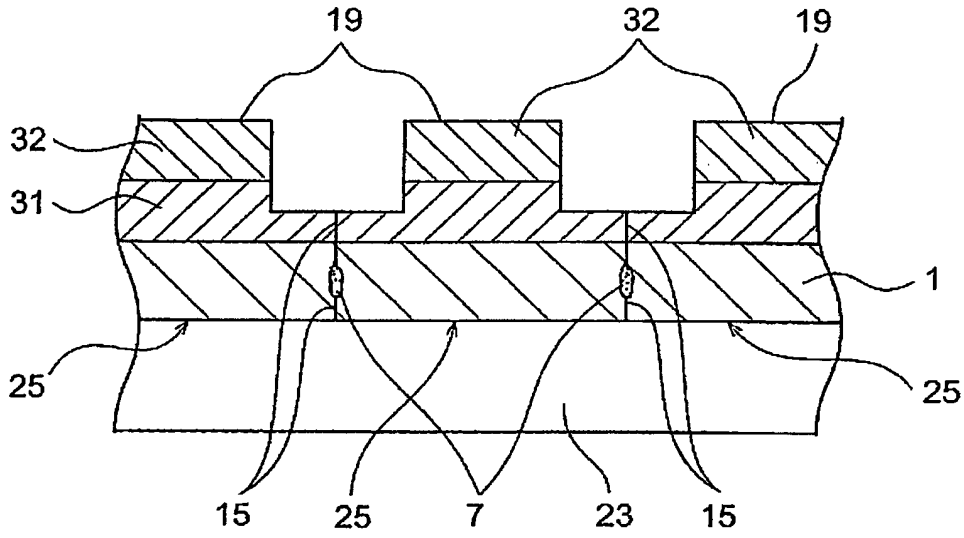
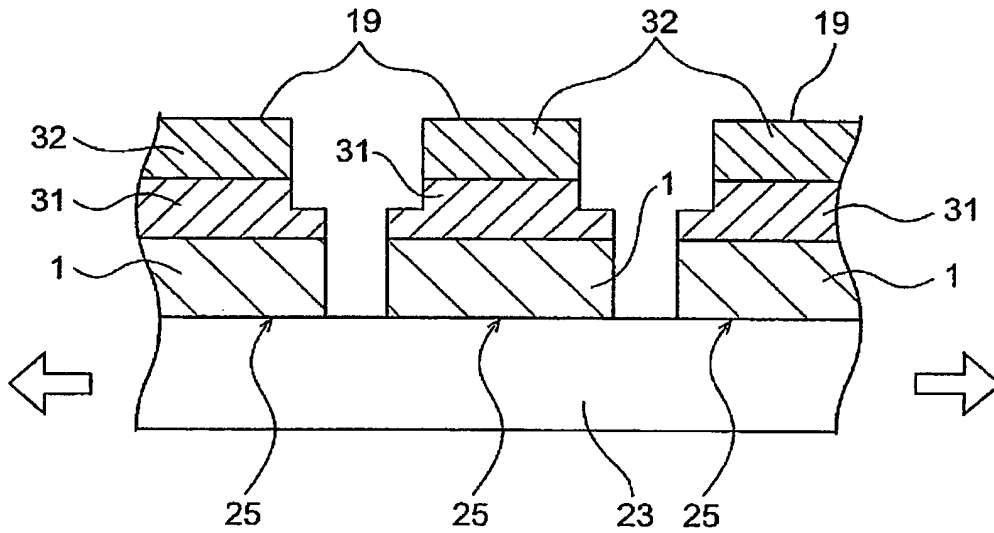

Fig.35



**This Page is Inserted by IFW Indexing and Scanning
Operations and is not part of the Official Record**

BEST AVAILABLE IMAGES

Defective images within this document are accurate representations of the original documents submitted by the applicant.

Defects in the images include but are not limited to the items checked:

- BLACK BORDERS
- IMAGE CUT OFF AT TOP, BOTTOM OR SIDES
- FADED TEXT OR DRAWING
- BLURRED OR ILLEGIBLE TEXT OR DRAWING
- SKEWED/SLANTED IMAGES
- COLOR OR BLACK AND WHITE PHOTOGRAPHS
- GRAY SCALE DOCUMENTS
- LINES OR MARKS ON ORIGINAL DOCUMENT
- REFERENCE(S) OR EXHIBIT(S) SUBMITTED ARE POOR QUALITY
- OTHER: _____

IMAGES ARE BEST AVAILABLE COPY.

As rescanning these documents will not correct the image problems checked, please do not report these problems to the IFW Image Problem Mailbox.